

Serie FS50

Kraftsensoren / Force Sensors

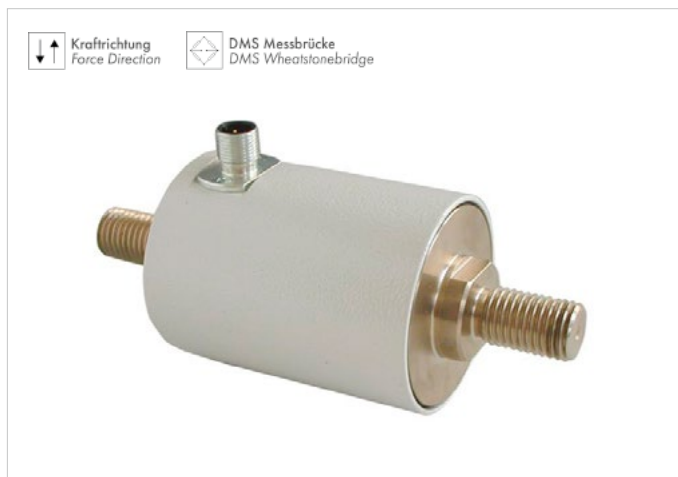

Inelta Kraftsensoren arbeiten mit Dehnungsmessstreifen (DMS)

Inelta Force Sensors operate with foil strain gauges

- Kraftmessung in Druck- und Zugrichtung
- Messbereiche 0,5kN bis 200kN
- Schutzart IP65
- Nenntemperaturbereich 0 .. +70°C
- Measurement for compression and tension
- Measuring ranges: 0,5kN bis 200kN
- Degree of protection IP65
- Operation temperature range 0 .. +70°C

Maßzeichnung / Drawing

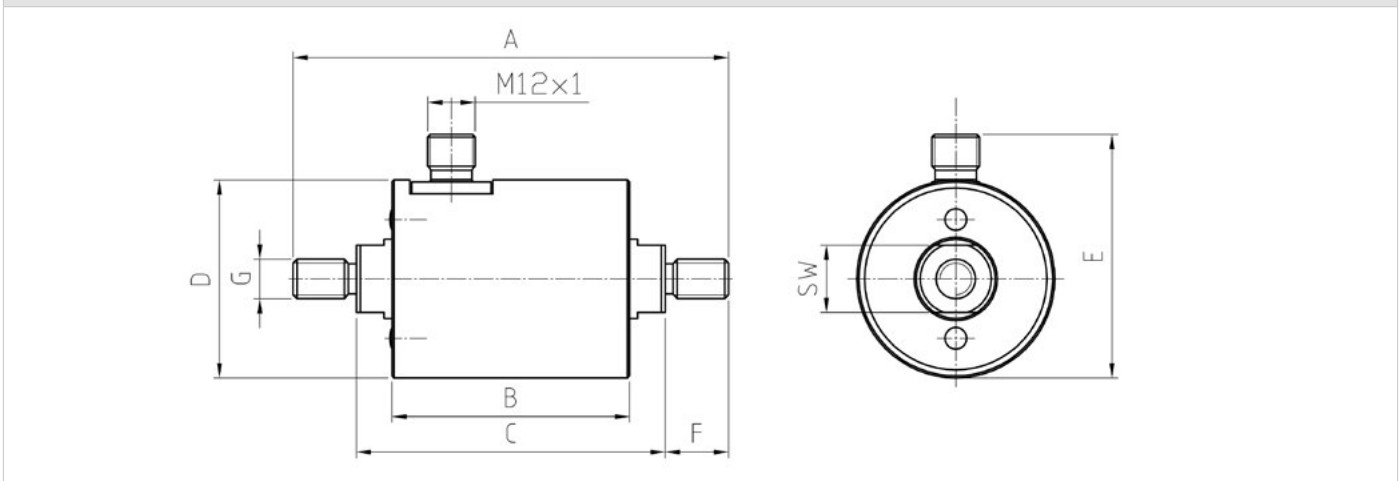

Standardtypen / Standard types

Typ / Type	Kraftmessbereich / Measuring range	Grenzkraft / Force limit	Ausgangssignal / Output Signal	Linearitätsabweichung / Linearity deviation	Temperatureinfluss auf Kennwert pro K / Temperature effect on characteristic value	A	B	D	Gewicht / Weight [g]
FS50-0,5kN	0,5kN	130 [% F.S.]	2 [mV/V]	< 0,1 [% F.S.]	< 0,1 [% F.S./10K]	95	55	45	312
FS50-1kN	1kN					95	55	45	338
FS50-2kN	2kN					110	60	50	449
FS50-5kN	5kN					110	60	50	483
FS50-10kN	10kN					140	80	60	786
FS50-20kN	20kN					150	80	60	954
FS50-50kN	50kN					170	80	60	1400
FS50-100kN	100kN					240	100	80	3440
FS50-200kN	200kN					300	120	100	Auf Anfrage / On request

Technische Spezifikation / Technical Specification										
Kraftmessbereich Measuring range	0,5	1	2	5	10	20	50	100	200	[kN]
Max. Gebrauchskraft Service load	120									[% F.S.]
Grenzkraft Limit load	130									[% F.S.]
Bruchlast Breaking load	> 200									[% F.S.]
Empfindlichkeit Sensitivity	2									[mV/V]
Rel. Abweichung d. Nullsignals Zero signal tolerance	2									[% F.S.]
Linearitätstabweichung Linearity deviation	< 0,1									[% F.S.]
Reproduzierbarkeit Repeatability	< 0,1									[% F.S.]
Kriechen (30 min) Creep error (30 min)	< 0,05									[% F.S.]
Hysterese Hysteresis	< 0,1									[% F.S.]
Grenzfrequenz fg Cut off frequency fg	500									[Hz]
Temp. einfluss auf Kennwert pro K Temperature effect on characteristic value	< 0,005									[% F.S./10K]
Temperatureinfluss auf Nullsignal pro K Temperature coefficient zero point	< 0,005									[% F.S./10K]
Grenzquerkraft (mechanisch) Limit lateral load	50									[% F.S.]
Nennmessweg Measuring displacement nom.	200									[µm]
Elektrische Spezifikation / Electrical Specification										
Speisespannung Nenn Excitation voltage nom.	10 (max. 15)									[V]
Eingangsimpedanz Input impedance	380 ± 10%									[Ω]
Ausgangsimpedanz Output impedance	350 ± 5%									[Ω]
Isolationswiderstand (bei 500 VDC) Isolation resistance (at 500 VDC)	> 5000									[MΩ]
Mechanische Spezifikation / Mechanical Specification										
Material, Messkörper Material, gauging	Stahl, vernickelt (optional: Edelstahl) Steel, nickel-plated (optional: stainless steel)									
Gehäusematerial Housing material	Stahl, powder-coated (optional: Edelstahl) Steel, powder-coated (optional: stainless steel)									
Messverfahren Measuring methode	DMS Messbrücke Wheatstonebridge									

Serie FS50

Kraftsensoren / Force Sensors

Umgebungsbedingungen / Environments		
Nenntemperaturbereich Operation temperature range	0 .. +70	[°C]
Lagerungstemperaturbereich Storage temperature range	-20 .. +120	[°C]
Relative Luftfeuchte (nicht kondensierend) Rel. humidity (not condensing)	95	[% r.H.]
Schutzart Degree of protection	IP65	

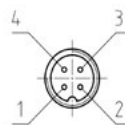





Anschlussbelegung / Connection		
PIN / PIN	Belegung / Configuration	
1	- Versorgung / - Excitation	
2	+ Versorgung / + Excitation	
3	+ Signal / + Signal	
4	- Signal / - Signal	
Gehäuse / Housing	Schirm / Shield	

Abmessungen / Dimensions								
	A	B	C	D	E	F	G	SW
500N	95	55	71	45	55	12	M8	13
1kN	95	55	71	45	55	12	M8	13
2kN	110	60	78	50	60	16	M10	17
5kN	110	60	78	50	60	16	M10	17
10kN	140	80	100	60	70	20	M12	19
20kN	150	80	104	60	70	23	M16	24
50kN	170	80	108	60	70	31	M24	30
100kN	240	100	136	80	90	52	M36	46
200kN	300	120	166	100	110	67	M48	65

Serie FS50

Kraftsensoren / Force Sensors

Zubehör / Equipment

Messwert-Verstärker Signal-Conditioner			
Serie / Series	IMA2-DMS	IVM2-DMS	IMK-DMS
Sensortyp Sensor type			
Versorgungsspannung Supply voltage	24 (18..36) 12 (9..18)	±15 ±5%	24 (18..36) 12 (9..18)
Stromverbrauch (ohne Last) [mA] Current consumption (without load)	<150 <300	10 .. 80	<150 <300
Einstellbereich Offset [V] Setting range offset	<±10	±8	<±10
Einstellbereich Verstärkung [%] Setting range amplification	<±10		<±10
Ausgangssignale Output signals	0-5V 0-10V ±5V ±10V 0-20mA 4-20mA	0 .. ±10 (max. 12, min. -12)	0-5V 0-10V 0-20mA 4-20mA
Datenblatt / Datasheet	170057	170060	170007

Optionen / Options

- Erweiterter Temperaturbereich (-40°C .. +120°C) / Extended temperature range (-40°C .. +120°C)
- Individuelle Kalibrierungen / Individual calibration service
- Sensorsignalverstärker (intern, extern) / Signal conditioner (internal, external)
- Normierter Ausgang (z.B. 4..20mA oder 0..10 Volt) / Scaled output (e.g. 4..20mA or 0..10 Volt)
- Edelstahlausführung / Stainless steel version
- Weitere Optionen auf Anfrage / More options on request